

Power Supply

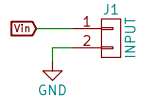

3.3 Voltage Regulator

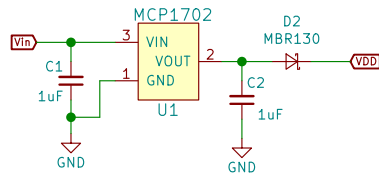

RGB LED

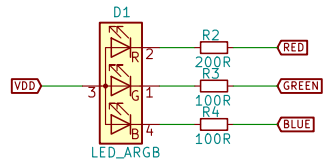

Production error in v0.3 batch
RGB LED is rotated by 90 degrees.
Only Red and Green are usable.

Reset

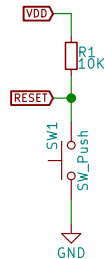

NFC Antenna Connector

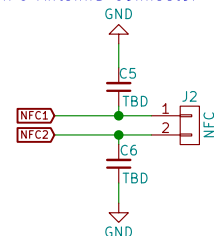

MDBT42 Module

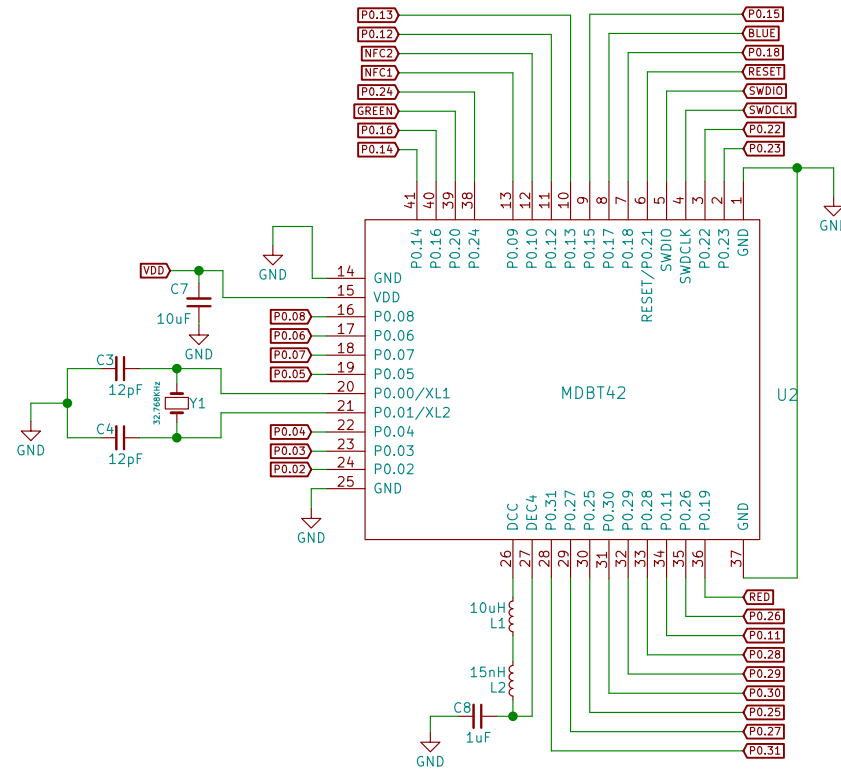

SWD Programming Pins

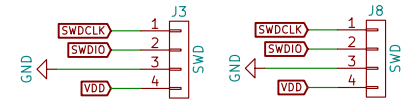

GPIO Pins

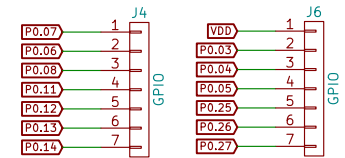

GPIO Pins

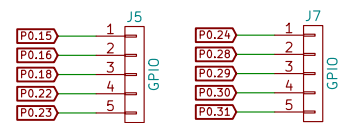

electronut.in

Electronut Labs

Sheet: /

File: hackaBLE.sch

Title: **hackaBLE**

Size: A4

Date: 2019-08-19

Rev: **0.3**

KiCad E.D.A. kicad (5.1.2)-1

Id: 1/1